



LEFROY BROOKS

IBROC HOUSE ESSEX ROAD
HODDESDON HERTS EN11 0QS UK
T: +44 (0)1992 708 316 F: +44 (0)1992 708 317

TH1247

TEN TEN WALL MOUNTED FIVE HOLE BATH FILLER
WITH HANDWHEELS, DIVERTER & HAND SHOWER

DIMENSIONAL DATA SHEET

DATE: 15/03/2024

REVISION: A

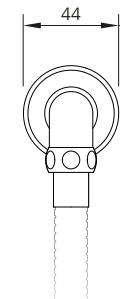
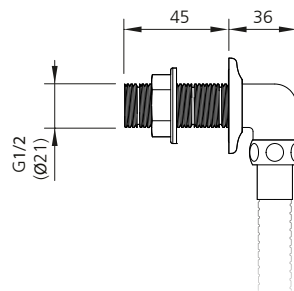
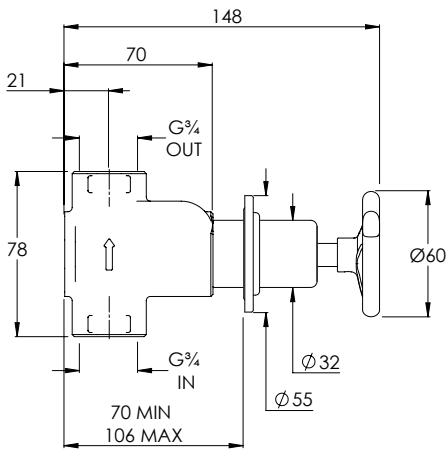
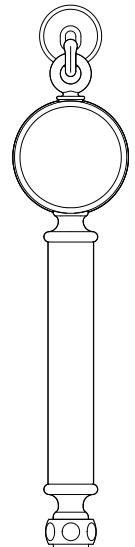
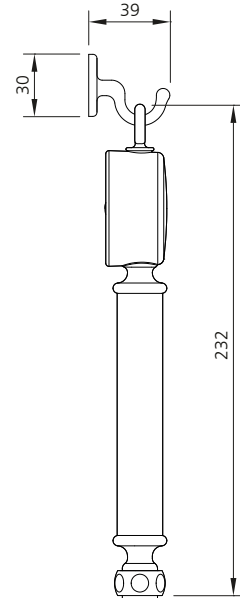
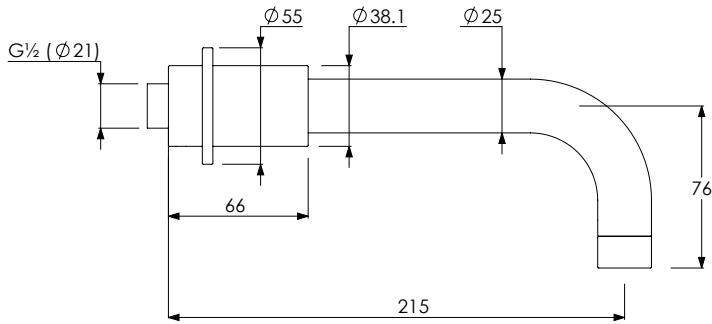
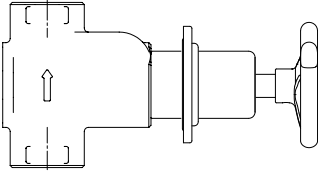
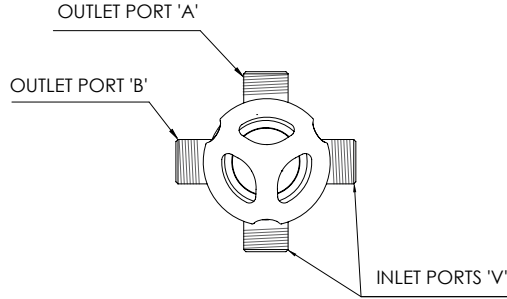
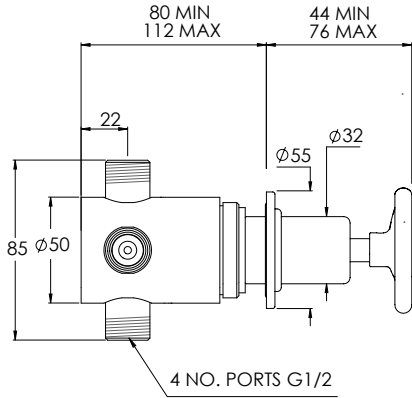

COPYRIGHT © LBIP LTD. ALL RIGHTS RESERVED

DIMENSIONS IN MILLIMETRES

WHILST EVERY EFFORT IS MADE TO ENSURE THE ACCURACY OF THESE DATA SHEETS THEY ARE SUBJECT TO CHANGE WITHOUT NOTICE AS PART OF THE COMPANY'S PRODUCT DEVELOPMENT PROCESS